



SERVICE AND OPERATING MANUAL
Model HDF3-M & HDF4-M
Type 2



See pages 15



Table of Contents

Engineering Data and Performance Curve..... 1
Explanation of Pump Nomenclature ..... 2
Dimensions..... 3
Principle of Operation ..... 4
Installation and Start-Up ..... 4
Air Supply ..... 4
Air Inlet & Priming..... 4
Installation Guide..... 5
ESADS+Plus®: Externally Serviceable Air Distribution System ..... 6
Air Exhaust ..... 7
Between Uses ..... 7
Check Valve Servicing..... 7
Diaphragm Servicing ..... 7
Pilot Valve..... 8
Pilot Valve Actuator..... 8
Service Instructions: Troubleshooting ..... 9
Warranty ..... 9
Material Codes ..... 10
Composite Repair Parts List..... 11-12
Composite Repair Drawing..... 13
CE Declaration of Conformity - Machinery ..... 14
CE Declaration fo Conformity - ATEX..... 15

# Safety Information

## IMPORTANT



Read the safety warnings and instructions in this manual before pump installation and start-up. Failure to comply with the recommendations stated in this manual could damage the pump and void factory warranty.



When the pump is used for materials that tend to settle out or solidify, the pump should be flushed after each use to prevent damage. In freezing temperatures the pump should be completely drained between uses.

## CAUTION



Before pump operation, inspect all fasteners for loosening caused by gasket creep. Retighten loose fasteners to prevent leakage. Follow recommended torques stated in this manual.



Nonmetallic pumps and plastic components are not UV stabilized. Ultraviolet radiation can damage these parts and negatively affect material properties. Do not expose to UV light for extended periods of time.

## RECYCLING

Many components of SANDPIPER® AODD pumps are made of recyclable materials. We encourage pump users to recycle worn out parts and pumps whenever possible, after any hazardous pumped fluids are thoroughly flushed.

## WARNING



When used for toxic or aggressive fluids, the pump should always be flushed clean prior to disassembly.



Before maintenance or repair, shut off the compressed air line, bleed the pressure, and disconnect the air line from the pump. Be certain that approved eye protection and protective clothing are worn at all times. Failure to follow these recommendations may result in serious injury or death.



Airborne particles and loud noise hazards. Wear eye and ear protection.



In the event of diaphragm rupture, pumped material may enter the air end of the pump, and be discharged into the atmosphere. If pumping a product that is hazardous or toxic, the air exhaust must be piped to an appropriate area for safe containment.



Take action to prevent static sparking. Fire or explosion can result, especially when handling flammable liquids. The pump, piping, valves, containers and other miscellaneous equipment must be properly grounded.



This pump is pressurized internally with air pressure during operation. Make certain that all fasteners are in good condition and are reinstalled properly during reassembly.



Use safe practices when lifting

## Grounding ATEX Pumps

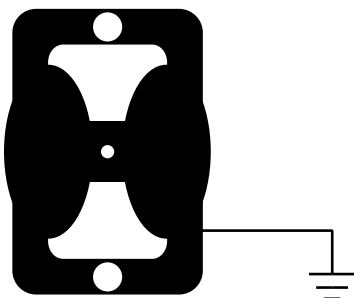

ATEX compliant pumps are suitable for use in explosive atmospheres when the equipment is properly grounded in accordance with local electrical codes. Pumps equipped with electrically conductive diaphragms are suitable for the transfer of conductive or non-conductive fluids of any explosion group. When operating pumps equipped with non-conductive diaphragms that exceed the maximum permissible projected area, as defined in EN 13461-1: 2009 section 6.7.5 table 9, the following protection methods must be applied:

- Equipment is always used to transfer electrically conductive fluids or
- Explosive environment is prevented from entering the internal portions of the pump, i.e. dry running

For further guidance on ATEX applications, please consult the factory.

**WARREN  
RUPP®**

Quality System  
ISO 9001 Certified

Environmental  
Management System  
ISO 14001 Certified

**IDEX**



**SANDPIPER®**

A WARREN RUPP PUMP BRAND

**Heavy Duty Flap Valve**

**HDF3-M  
HDF4-M Type 2**

**Air-Operated  
Double Diaphragm Pump**

ENGINEERING, PERFORMANCE  
& CONSTRUCTION DATA



See pages 17 & 18  
for ATEX ratings

INTAKE/DISCHARGE PIPE SIZE	CAPACITY	AIR VALVE	SOLIDS-HANDLING	HEADS UP TO
HDF3-M: 3" 150# ANSI Flange HDF4-M: 4" 150# ANSI Flange	0 to 260 gallons per minute (0 to 988 liters per minute)	No-lube, no-stall design	Up to nearly 3" (75mm)	125 psi or 289 ft. of water (8.8 Kg/cm <sup>2</sup> or 88 meters)

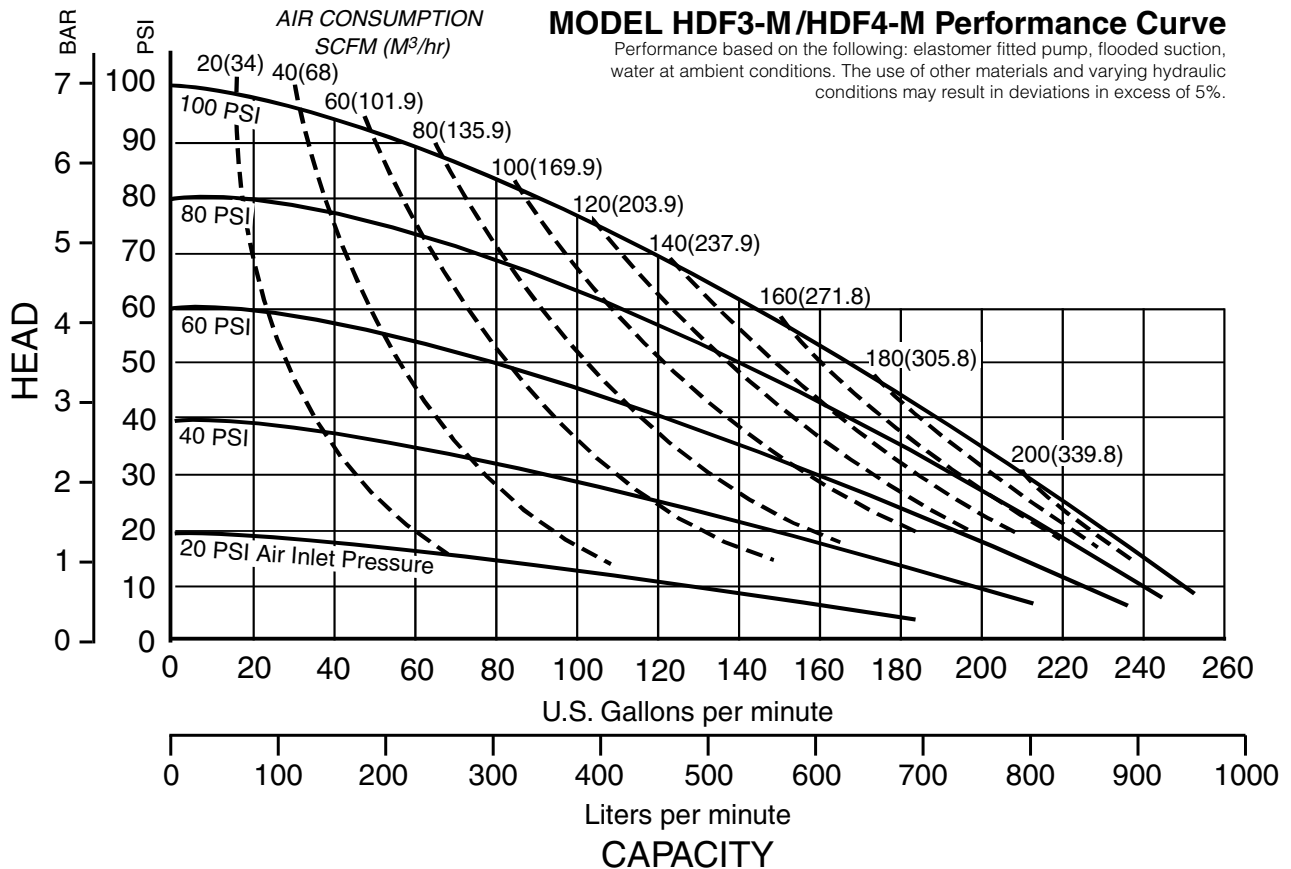

SANDPIPER® pumps are designed to be powered only by compressed air.

# Explanation of Pump Nomenclature, HDF3-M & HDF4-M

## MATERIALS OF CONSTRUCTION

To order a pump or replacement parts, first enter the Model Number **HDF3-M**, or **HDF4-M**, followed by the Type Designation listed below in the far left column.

HDF3-M Type	Manifold Elbow	Outer Chamber	Inner Chamber	Outer Diaphragm Plates	Inner Diaphragm Plate	Intermediate Housing	Diaphragm Rod	Valve Seat	Hardware	Diaphragm	Flap Valve Material	Seat Gasket	Sealing Rings	Shipping Wt. (lbs)
DA2II	CI	CI	DI	CI	PS	CI	416SS	SS	PS	N	U	A	B	245
DN2II	CI	CI	DI	CI	PS	CI	416SS	SS	PS	N	N	A	B	363
DB2II	CI	CI	DI	CI	PS	CI	416SS	SS	PS	B	B	A	B	363
DK2II	CI	CI	DI	CI	PS	CI	416SS	SS	PS	N	H	A	B	363
DS2II										S	S			
HDF4-M Type 2														
DN2II	CI	CI	DI	CI	PS	CI	416SS	SS	PS	N	N	A	B	390
DB2II	CI	CI	DI	CI	PS	CI	416SS	SS	PS	B	B	A	B	390
DA2II	CI	CI	DI	CI	PS	CI	416SS	SS	PS	N	U	A	B	390
DS2II										S	S			

### Meanings of Abbreviations:

A = Compressed Fibre  
 B = Nitrile  
 CI = Cast Iron  
 DI = Ductile Iron  
 H = Hytrel®  
 N = Neoprene  
 PS = Plated Steel  
 SS = Stainless Steel  
 U = Urethane  
 S = Santoprene

Most types available in dual port design. See price book or consult factory for details.

Hytrel is a registered tradename of E.I. du Pont. Santoprene is a registered tradename of Exxon Mobil Corp.

Maximum and Minimum Temperatures are the limits for which these materials can be operated. Temperatures coupled with pressure affect the longevity of diaphragm pump components. Maximum life should not be expected at the extreme limits of the temperature ranges.

Materials	Operating Temperatures	
	Maximum	Minimum
<b>Nitrile</b> General purpose, oil-resistant. Shows good solvent, oil, water and hydraulic fluid resistance. Should not be used with highly polar solvents like acetone and MEK, ozone, chlorinated hydrocarbons and nitro hydrocarbons.	190°F 88°C	-10°F -23°C
<b>NEOPRENE</b> All purpose. Resistant to vegetable oils. Generally not affected by moderate chemicals, fats, greases and many oils and solvents. Generally attacked by strong oxidizing acids, ketones, esters, nitro hydrocarbons and chlorinated aromatic hydrocarbons.	200°F 93°C	-10°F -23°C
<b>HYTREL®</b> Good on acids, bases, amines and glycols at room temperature.	220°F 104°C	-20°F -29°C
<b>Urethane</b> Shows good resistance to abrasives. Has poor resistance to most solvents and oils.	150°F 66°C	+32°F 0°C
<b>Santoprene®</b> Injection molded thermoplastic elastomer with no fabric layer. Long mechanical flex life. Excellent abrasion resistance.	275°F 135°C	-40°F -40°C
‡ <b>CF-8M Stainless Steel</b> equal to or exceeding ASTM specification A743 for corrosion resistant iron chromium, iron chromium nickel, and nickel based alloy castings for general applications. Commonly referred to as 316 Stainless Steel in the pump industry.		

For specific applications, always consult "Chemical Resistance Chart" Technical Bulletin



II 1 G c T5  
 II 1 D c T100°C  
 IM1 c  
 IM2 c

Models equipped with Cast Iron wetted parts, and Cast Iron midsection parts.

# Dimensions: HDF3-M & HDF4-M

Dimensions are ± 1/8"  
 Figures in parenthesis = millimeters

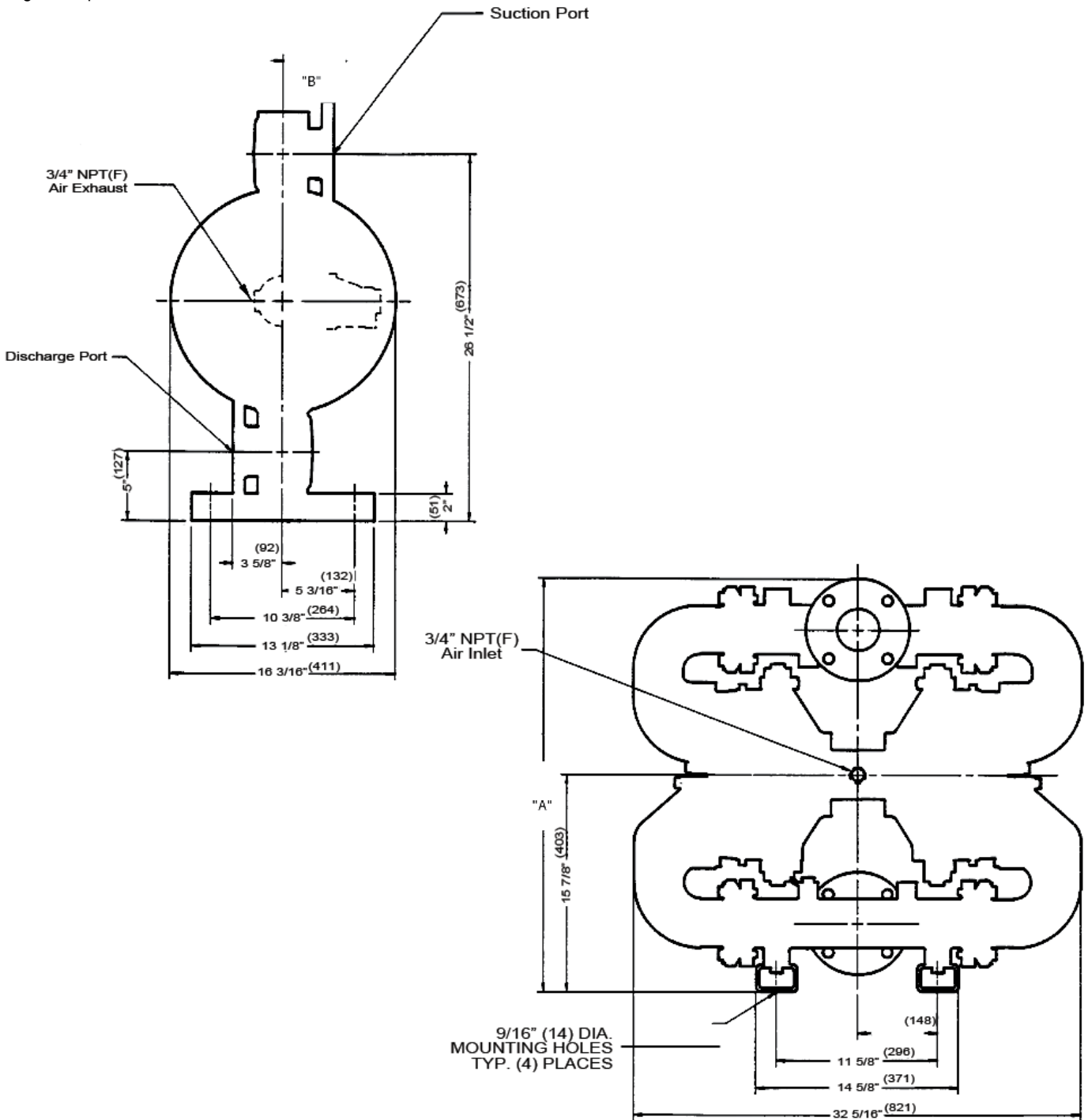

	HDF3-M	HDF4
<b>Suction &amp; Discharge Ports</b>	Four(4) 3/4" dia. thru holes equally spaced on a 6" diameter bolt circle	4" Eight(8) 5/8-11 unc tapped holes equally spaced on a 7 1/2" diameter bolt circle
<b>Dimension "A"</b>	30 1/4" (768)	31" (787)
<b>Dimension "B"</b>	3 3/8" (92)	6 5/8" (168)



# SERVICE AND OPERATING MANUAL

## Model HDF3-M & HD4F-M

### Type 2

## Heavy Duty Flap Valve

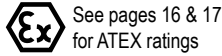

### PRINCIPLE OF PUMP OPERATION

This flap swing valve pump is powered by compressed air and is a 1:1 pressure ratio design. It alternately pressurizes the inner side of one diaphragm chamber, while simultaneously exhausting the other inner chamber. This causes the diaphragms, which are connected by a common rod, to move endwise. Air pressure is applied over the entire surface of the diaphragm, while liquid is discharged from the opposite side. The diaphragm operates under a balanced condition during the discharge stroke, which allows the unit to be operated at discharge heads over 200 feet (61 meters) of water head.

Since the diaphragms are connected by a common rod, secured by plates to the center of the diaphragms, one diaphragm performs the discharge stroke, while the other is pulled to perform the suction stroke in the opposite chamber.

For maximum diaphragm life, keep the pump as close to the liquid being pumped as possible. Positive suction head in excess of 10 feet of liquid (3.048 meters) may require a back pressure regulating device. This will maximize diaphragm life.

Alternate pressuring and exhausting of the diaphragm chamber is performed by means of an externally mounted, pilot operated, four-way spool type air distribution valve. When the spool shifts to one end of the valve body, inlet air pressure is applied to one diaphragm chamber and the other diaphragm chamber exhausts. When the spool shifts to the opposite end of the valve body, the porting of chambers is reversed. The air distribution valve spool is moved by an internal pilot valve which alternately pressurizes one side of the air distribution valve spool, while exhausting the other side. The pilot valve is shifted at each end of the diaphragm stroke by the diaphragm plate coming in contact with the end of the pilot spool. This pushes it into position for shifting of the air distribution valve.

The chambers are manifolded together with a suction and discharge flap-type valve for each chamber, maintaining flow in one direction through the pump

### INSTALLATION & START-UP

Locate the pump as close to the product being pumped as possible, keeping suction line length and number of fittings to a minimum. Do not reduce line size.

For installations of rigid piping, short flexible sections of hose should be installed between pump and piping. This reduces vibration and strain to the piping system. A surge suppressor is recommended to further reduce pulsation in flow.

This pump was tested at the factory prior to shipment and is ready for operation. It is completely self-priming from a dry start for suction lifts of 20 feet (6.096 meters) or less. For suction lifts exceeding 20 feet of liquid, fill the chambers with liquid prior to priming.

### AIR SUPPLY

Air supply pressures cannot exceed 125 psi (8.61 bar). Connect the pump air inlet to an air supply of sufficient capacity and pressure required for desired performance. When the air line is solid piping, use a short length of flexible hose [not less than 3/4" (19mm) in diameter] between pump and piping to eliminate strain to pipes.

### AIR INLET & PRIMING

For start-up, open an air valve approximately 1/2" to 3/4" turn. After the unit primes, an air valve can be opened to increase flow as desired. If opening the valve increases cycling rate, but does not increase flow rate, cavitation has occurred, and the valve should be closed slightly.

For the most efficient use of compressed air and the longest diaphragm life, throttle the air inlet to the lowest cycling rate that does not reduce flow.

- Available from Distributor
- Available from Warren Rupp

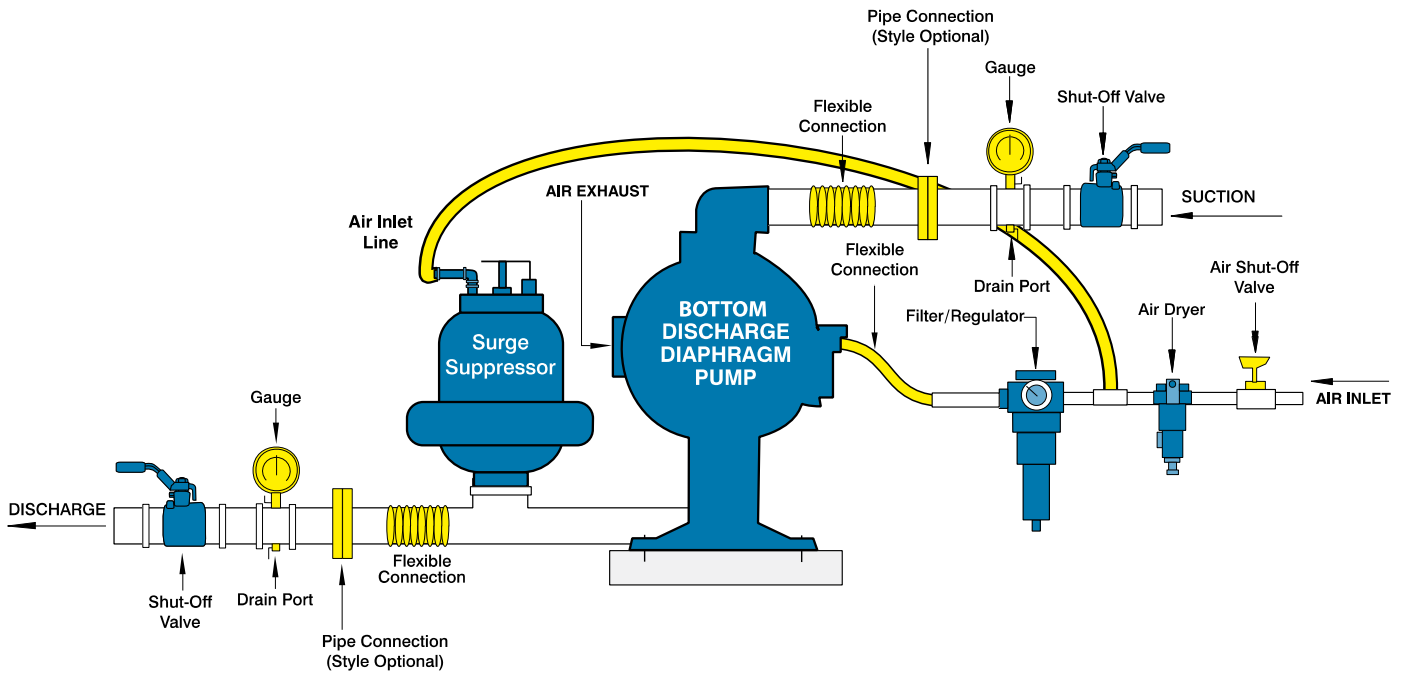
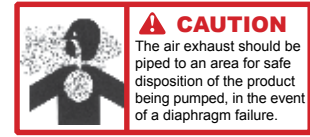

## **A NOTE ABOUT AIR VALVE LUBRICATION**

The SANDPIPER pump's pilot valve and main air valve assemblies are designed to operate WITHOUT lubrication. This is the preferred mode of operation. There may be instances of personal preference, or poor quality air supplies when lubrication of the compressed air supply is required. The pump air system will operate with properly lubricated compressed air supplies. Proper lubrication of the compressed air supply would entail the use of an air line lubricator (available from Warren Rupp) set to deliver one drop of 10 wt., non-detergent oil for every 20 SCFM of air the pump consumed at its point of operation. Consult the pump's published Performance Curve to determine this.

It is important to remember to inspect the sleeve and spool set routinely. It should move back and forth freely. This is most important when the air supply is lubricated. If a lubricator is used, oil accumulation will, over time, collect any debris from the compressed air. This can prevent the pump from operating properly.

Water in the compressed air supply can create problems such as icing or freezing of the exhaust air causing the pump to cycle erratically, or stop operating. This can be addressed by using a point of use air dryer to supplement a plant's air drying equipment. This device will remove excess water from the compressed air supply and alleviate the icing or freezing problem.

## **ESADS+PLUS: EXTERNALLY SERVICEABLE AIR DISTRIBUTION SYSTEM**

Please refer to the exploded view drawing and parts list in the Service Manual supplied with your pump. If you need replacement or additional copies, contact your local Warren Rupp Distributor, or the Warren Rupp factory Literature Department at the number shown below. To receive the correct manual, you must specify the MODEL and TYPE information found on the name plate of the pump.

## **MODELS WITH 1" SUCTION/DISCHARGE OR LARGER, AND METAL CENTER SECTIONS:**

The main air valve sleeve and spool set is located in the valve body mounted on the pump with four hex head capscrews. The valve body assembly is removed from the pump by removing these four hex head capscrews.

With the valve body assembly off the pump, access to the sleeve and spool set is made by removing four hex head capscrews (each end) on the end caps of the valve body assembly. With the end caps removed, slide the spool back and forth in the sleeve. The spool is closely sized to the sleeve and must move freely to allow for proper pump operation. An accumulation of oil, dirt or other contaminants from the pump's air supply, or from a failed diaphragm, may prevent the spool from moving freely. This can cause the spool to stick in a position that prevents the pump from operating. If this is the case, the sleeve and spool set should be removed from the valve body for cleaning and further inspection.

Remove the spool from the sleeve. Using an arbor press or bench vise (with an improvised mandrel), press the sleeve from the valve body. Take care not to damage the sleeve. At this point, inspect the o-rings on the sleeve for nicks, tears or abrasions. Damage of this sort could happen during assembly or servicing. A sheared or cut o-ring can allow the pump's compressed air supply to leak or bypass within the air valve assembly, causing the pump to leak compressed air from the pump air exhaust or not cycle properly. This is most noticeable at pump dead head or high discharge pressure conditions. Replace any of these o-rings as required or set up a routine, preventive maintenance schedule to do so on a regular basis. This practice should include cleaning the spool and sleeve components with a safety solvent or equivalent, inspecting for signs of wear or damage, and replacing worn components.

To re-install the sleeve and spool set, lightly lubricate the o-rings on the sleeve with an o-ring assembly lubricant or lightweight oil (such as 10 wt. air line lubricant). Re-install one end cap, gasket and bumper on the valve body. Using the arbor press or bench vise that was used in disassembly, carefully press the sleeve back into the valve body, without shearing the o-rings. You may have to clean the surfaces of the valve body where the end caps mount. Material may remain from the old gasket. Old material not cleaned from this area may cause air leakage after reassembly. Take care



that the bumper stays in place allowing the sleeve to press in all the way. Reinstall the spool, opposite end cap, gasket and bumper on the valve body. After inspecting and cleaning the gasket surfaces on the valve body and intermediate, reinstall the valve body on the pump using new gaskets. Tighten the four hex head capscrews evenly and in an alternating cross pattern.

## **AIR EXHAUST**

If a diaphragm fails, the pumped liquid or fumes can enter the air end of the pump, and be exhausted into the atmosphere. When pumping hazardous or toxic materials, pipe the exhaust to an appropriate area for safe disposition.

This pump can be submerged if materials of construction are compatible with the liquid. The air exhaust must be piped above the liquid level. Piping used for the air exhaust must not be smaller than 1" (2.54 cm). Reducing the pipe size will restrict air flow and reduce pump performance. When the product source is at a higher level than the pump (flooded suction), pipe the exhaust higher than the product source to prevent siphoning spills.

Freezing or icing-up of the air exhaust can occur under certain temperature and humidity conditions. Use of an air dryer unit should eliminate most icing problems.

## **BETWEEN USES**

When used for materials that tend to settle out or transform to solid form, the pump should be completely flushed after each use, to prevent damage. Product remaining in the pump between uses could dry out or settle out. This could cause problems with valves and diaphragms at re-start. In freezing temperatures, the pump must be drained between uses in all cases.

## **FLAP VALVE SERVICING**

Valve inspection requires removal of 3/8" hex nuts and elbows. When the top suction elbows are removed, the valve and seat are connected as an assembly. When the bottom discharge elbows are removed, the valve and seat stay with the outer chamber. Visual inspection and cleaning is possible. If parts are to be replaced, remove the self-locking nuts and all parts are accessible.

## **DIAPHRAGM SERVICING**

Diaphragms can be inspected or the diaphragm assembly removed without removing the suction and discharge flanges. Remove (8) nuts around the chamber flange, and the housing assembly will pull off. Flap valves can be inspected for proper seating at this point as well as the diaphragm. Use care to keep foreign matter from behind the diaphragm. The opposite diaphragm may be inspected by the same procedure. If either diaphragm has to be replaced, follow closely these steps: Pull the outer diameter of one diaphragm off the (8) capscrews. NOTE: One side only! On the free diaphragm assembly, use a 3/8" allen wrench to turn the assembly (diaphragm, plates and screw) loose from the shaft. Once the assembly has turned, it will turn out by hand by use of the diaphragm. Now the opposite diaphragm assembly and the drive shaft will pull free from the capscrews and pump intermediate assembly. The interior components consisting of sleeve bearings, rod seals, and pilot valve actuator bushings are now accessible for service if required. Hold the shaft in a clamping device making sure to protect surface of shaft so as not to scratch or mar it in any way. The diaphragm assembly will turn loose. To disassemble the components, turn a 1/4"-20 capscrew by hand into the tapped hole in the inner plate. This keeps the plate from turning while the socket head capscrew is removed. To do this, place assembly in a vise so the two protruding ends of screws are loose in the vise jaws (about 3/4" apart). Turn the center screw loose from the back plate and the assembly will come apart.

## REASSEMBLY

All procedures for reassembling the pump are the reverse of the previous instructions with further instructions as shown:

1. The diaphragm assemblies are to be installed with the natural bulge outward or toward the head of the center screw. Make sure both plates are installed with outer radii against the diaphragm. After all components are in position in a vise and hand tight, set a torque wrench for 480 inch pounds (40 ft. pounds) (54.23 Newton meters) or, 600 inch pounds (50 ft. pounds) (67.79 Newton meters) for Santoprene, using a (3/8") allen head socket. After each diaphragm sub assembly has been completed, thread one assembly into the shaft (held near the middle in a vise having soft jaws to protect the finish) making sure the stainless steel washer is in place on the capscrew.

Make sure 1/4"-20 mounting screw has been removed and that the bumper (Item #19 on drawing) is in place in the shaft.

Install this sub assembly into the pump and secure by placing the outer chamber housing and capscrews on the end with the diaphragm. This will hold the assembly in place while the opposite side is installed. Make sure the last diaphragm assembly is torqued to 30 ft. lbs. (40.67 Newton meters) before placing the outer diaphragm over the capscrews. If the holes in the diaphragm flange do not line up with the holes in the chamber flange, turn the diaphragm assembly in the direction of tightening to align the holes so that the capscrews can be inserted. This final torquing of the last diaphragm assembly will lock the two diaphragm assemblies together. Place remaining outer chamber on the open end and tighten down the securing nuts gradually and evenly on both sides.

Caution should be used while reassembling Flap valves. The valves are designed for some preload over the retainer hinge pad. This is done to insure proper face contact with the seat. After all parts are in place, tighten the lock nuts down on the assembly to the point where visual inspection shows that seat and valve face mate without gap. This is important for dry prime. However, after priming action has started, valves will function due to differential pressure without concern or trouble.

## PILOT VALVE

The pilot valve assembly is accessed by removing the main air distribution valve body from the pump and lifting the pilot valve body out of the intermediate housing.

Most problems with the pilot valve can be corrected by replacing the o-rings. Always grease the spool prior to inserting it into the sleeve. If the sleeve is removed from the body, reinsertion must be at the chamfered side. Grease the o-rings to slide the sleeve into the valve body. Securely insert the retaining ring around the sleeve. When reinserting the pilot valve, push both plungers (located inside the intermediate bracket) out of the path of the pilot valve spool ends to avoid damage.

## PILOT VALVE ACTUATOR

Bushings for the pilot valve actuators are threaded into the intermediate bracket from the outside. The plunger may be removed for inspection or replacement. First remove the air distribution valve body and the pilot valve body from the pump. The plungers can be located by looking into the intermediate. It may be necessary to use a fine piece of wire to pull them out. The bushing can be turned out through the inner chamber by removing the outer chamber assembly. Replace the bushings if pins have bent.

## **TROUBLESHOOTING - For additional information, see the Warren Rupp Troubleshooting Guide.**

### **PROBLEM**

Pump cycles but will not pump. (Note: higher suction lifts require faster cycling speed for priming.)

### **POSSIBLE CAUSES:**

- A. Air leak in suction line.
- B. Excessive suction lift.
- C. Flap valve not seating properly.
- D. Leakage at joint of suction manifold or elbow flange.
- E. Suction line or strainer plugged.
- F. Diaphragm ruptured.

### **PROBLEM**

Pump will not cycle. (Note: Always disconnect air supply to relieve air pressure before disassembling any portion of pump.)

### **POSSIBLE CAUSES:**

- A. Discharge hose or line plugged, or discharge head requirement greater than air supply pressure.  
(Disconnect discharge line to check.)
- B. Spool in air distribution valve not shifting. (Remove end cap and check spool — must slide freely.)
- C. Diaphragm ruptured. (Air will escape out discharge line in this case.)
- D. Blockage in diaphragm chamber preventing movement. (Shut off air supply and reopen after pressure is relieved.)

### **PROBLEM**

Uneven discharge flow. (Indicates one chamber not operating properly.)

### **POSSIBLE CAUSES:**

- A. Flap valve not sealing properly in one chamber.
- B. Diaphragm failure in one chamber.
- C. Air leak at suction manifold joint or elbow flange one side.

For additional information, see the Warren Rupp Troubleshooting Guide.

## **WARRANTY:**

This unit is guaranteed for a period of five years against defective material and workmanship.

### **RECOMMENDED WARREN RUPP ACCESSORIES TO MAXIMIZE PUMP PERFORMANCE:**

- **Tranquilizer® Surge Suppressor:** For nearly pulse-free flow.
- **Warren Rupp Filter/Regulator:** For modular installation and service convenience.
- **Warren Rupp Speed Control:** For manual or programmable process control. Manual adjustment or 4-20mA reception.

*For more detailed information on these accessories,  
contact your local Warren Rupp Factory-Authorized Distributor,  
or Warren Rupp corporate headquarters.*

## MATERIAL CODES THE LAST 3 DIGITS OF PART NUMBER

000	Assembly, sub-assembly; and some purchased items	353	Geolast; Color: BLACK	557	Conductive Polypropylene; Color: BLACK; Color Coded: SILVER
010	Cast Iron	354	Injection Molded #203-40 Santoprene- Duro 40D +/-5; Color: RED	558	Conductive HDPE; Color: BLACK Color Coded: SILVER
012	Powered Metal	355	Thermal Plastic	559	Conductive Polypropylene; Color: BLACK Color Coded: SILVER
015	Ductile Iron	356	HytreI; Color: BLUE	570	Rulon II
020	Ferritic Malleable Iron	357	Injection Molded Polyurethane; Color: GREEN	580	Ryton
025	Music Wire	358	Urethane Rubber; Color: NATURAL (Some Applications)	590	Valox
080	Carbon Steel, AISI B-1112		(Compression Mold)	591	Nylatron G-S
100	Alloy 20		Urethane Rubber; Color: NATURAL	592	Nylatron NSB
110	Alloy Type 316 Stainless Steel	359	Nitrile Rubber; Color Coded: RED	600	PTFE (virgin material)
111	Alloy Type 316 Stainless Steel (Electro Polished)	360	Nitrile		Tetrafluorocarbon (TFE)
112	Alloy C	361	FKM (Fluorocarbon). Color Coded: YELLOW	601	PTFE (Bronze and moly filled)
113	Alloy Type 316 Stainless Steel (Hand Polished)	363	E.P.D.M. Rubber. Color Coded: BLUE	602	Filled PTFE
114	303 Stainless Steel	364	Neoprene Rubber; Color Coded: GREEN	603	Blue Gylon
115	302/304 Stainless Steel	365	Food Grade Nitrile; Color: WHITE	604	PTFE
117	440-C Stainless Steel (Martensitic)	366	Food Grade EPDM; Color: GRAY	606	PTFE
120	416 Stainless Steel (Wrought Martensitic)	368	Butyl Rubber Color Coded: BROWN	607	Envelon
123	410 Stainless Steel (Wrought Martensitic)	370	Philthane (Tuftane)	608	Conductive PTFE; Color: BLACK
148	Hardcoat Anodized Aluminum	371	Carboxylated Nitrile	610	PTFE Encapsulated Silicon
149	2024-T4 Aluminum	374	Fluorinated Nitrile	611	PTFE Encapsulated FKM
150	6061-T6 Aluminum	375	High Density Polypropylene	632	Neoprene/Hytrel
151	6063-T6 Aluminum	378	Conductive Nitrile; Color Coded: RED & SILVER	633	FKM/PTFE
152	2024-T4 Aluminum (2023-T351)	379	Conductive Neoprene; Color Coded: GREEN & SILVER	634	EPDM/PTFE
154	Almag 35 Aluminum	384	Cellulose Fibre	635	Neoprene/PTFE
155	356-T6 Aluminum	405	Cork and Neoprene	637	PTFE , FKM/PTFE
156	356-T6 Aluminum	408	Compressed Fibre	638	PTFE , Hytrel/PTFE
157	Die Cast Aluminum Alloy #380	425	Blue Gard	639	Nitrile/TFE
158	Aluminum Alloy SR-319	426	Vegetable Fibre	643	Santoprene®/EPDM
159	Anodized Aluminum	440	Fibre	644	Santoprene®/PTFE
162	Brass, Yellow, Screw Machine Stock	465	Delrin 500	656	Santoprene Diaphragm and Check Balls/EPDM Seats
165	Cast Bronze, 85-5-5-5	500	Delrin 570	661	EPDM/Santoprene
166	Bronze, SAE 660	501	Conductive Acetal, ESD-800; Color: BLACK	666	FDA Nitrile Diaphragm, PTFE Overlay, Balls, and Seals
170	Bronze, Bearing Type, Oil Impregnated	502	Conductive Acetal, Glass-Filled Color: BLACK; Color Coded: YELLOW	668	PTFE, FDA Santoprene/PTFE
175	Die Cast Zinc	503	Acrylic Resin Plastic		
180	Copper Alloy	505	Delrin 150		
305	Carbon Steel, Black Epoxy Coated	506	Injection Molded PVDF; Color: NATURAL		
306	Carbon Steel, Black PTFE Coated	521	Injection Molded Conductive PVDF; Color: BLACK; Color Coded: LIGHT GREEN		
307	Aluminum, Black Epoxy Coated	540	Nylon		
308	Stainless Steel, Black PTFE Coated	541	Nylon		
309	Aluminum, Black PTFE Coated	542	Nylon		
310	PVDF Coated	544	Nylon Injection Molded		
313	Aluminum, White Epoxy Coated	550	Polyethylene		
330	Zinc Plated Steel	551	Glass Filled Polypropylene; Color: BLACK		
331	Chrome Plated Steel	552	Unfilled Polypropylene; Color: NATURAL		
332	Aluminum, Electroless Nickel Plated	555	Polyvinyl Chloride		
333	Carbon Steel, Electroless Nickel Plated	556	Black Vinyl		
335	Galvanized Steel				
336	Zinc Plated Yellow Brass				
337	Silver Plated Steel				
340	Nickel Plated				
342	Filled Nylon				
351	Food Grade Santoprene; Color: NATURAL				

Delrin is a registered  
tradename of E.I. DuPont.

Gylon is a registered tradename  
of Garlock, Inc.

Nylatron is a registered tradename  
of Polymer Corp.

Santoprene is a registered tradename  
of Exxon Mobil Corp.

Rulon II is a registered tradename  
of Dixon Industries Corp.

Ryton is a registered tradename  
of Phillips Chemical Co.

Valox is a registered tradename  
of General Electric Co.

PortaPump, Tranquilizer and SludgeMaster are  
registered tradenames of Warren Rupp, Inc.



ITEM NO.	PART NUMBER	DESCRIPTION	TOTAL RQD.
1	070.006.170.	Bearing, Sleeve	2
2	114.002.010.	Bracket, Intermediate	1
3	132.022.360.	Bumper	2
4	<b>135.016.162.</b>	<b>Bushing, Threaded, with O-Ring</b>	<b>2</b>
5	<b>620.011.114.</b>	<b>Plunger, Actuator</b>	<b>2</b>
7	<b>360.041.379.</b>	<b>Gasket, Valve Body</b>	<b>1</b>
8	<b>560.001.360.</b>	<b>O-Ring</b>	<b>2</b>
9	<b>132.014.358.</b>	<b>Bumper, Valve Spool</b>	<b>2</b>
10	<b>095.073.001.</b>	<b>Pilot Valve Assembly</b>	<b>1</b>
10-A	095.070.558.	Pilot Valve Body	1
10-B	755.025.000.	Sleeve, with O-Ring	1
10-C	560.033.360.	O-Ring (Sleeve)	4
10-D	775.026.000.	Spool, with O-Ring	1
10-E	560.023.360.	O-Ring (Spool)	2
10-F	675.037.080.	Retaining Ring	1
11	165.011.010.	Cap, End	2
12	360.048.425.	Gasket, Valve Body	1
13	360.010.425.	Gasket, End Cap	2
14	560.020.360.	O-Ring	6
15	031.018.000.	Sleeve & Spool Set	1
16	170.032.330.	Capscrew, Hex Head	8
17	095.043.010.	Body, Valve	1
18	196.100.015.	Chamber, Inner	2
19	<u>560.022.360.</u>	O-Ring	2
20	<b>170.045.330.</b>	<b>Capscrew, Hex Head</b>	<b>4</b>
21	<b>530.036.000.</b>	<b>Muffler, Exhaust</b>	<b>1</b>
22	<b>685.041.120.</b>	<b>Rod, Diaphragm</b>	<b>1</b>
23	<b>115.068.080.</b>	<b>Bracket, Support</b>	<b>1</b>
24	<b>170.024.330.</b>	<b>Capscrew, Hex Head</b>	<b>8</b>
25	<b>900.006.330.</b>	<b>Washer, Lock</b>	<b>8</b>
26	<b>720.004.360.</b>	<b>Seal, U-Cup</b>	<b>2</b>
27	<b>722.007.115.</b>	<b>Seat, Flap Valve-Angle</b>	<b>4</b>
28	326.004.080.	Mounting Foot	2
29	<b>132.002.360.</b>	<b>Bumper</b>	<b>2</b>
30	612.090.010.	Plate, Outer Diaphragm Assy.	2
31	<b>807.046.330.</b>	<b>Stud</b>	<b>2</b>
32	612.124.010.	Plate, Inner Diaphragm	2
33	<b>286.098.365.</b>	<b>Diaphragm</b>	<b>2</b>
	286.098.360.	Diaphragm	2
	286.098.354.	Diaphragm	2
34	900.003.330.	Washer, Lock	22
35	545.008.330.	Nut, Hex	16
39	807.017.330.	Stud	8
40	618.003.330.	Pipe Plug	4
41	900.006.330.	Washer, Lock	4
42	170.012.330.	Capscrew, Hex Head	6
43	<b>360.013.379.</b>	<b>Gasket, Seat</b>	<b>4</b>
	<b>360.013.384.</b>	<b>Gasket, Seat</b>	<b>4</b>

ITEM NO.	PART NUMBER	DESCRIPTION	TOTAL RQD.
44	<b>360.014.379.</b>	<b>Gasket, Flange</b>	<b>4</b>
	<b>360.014.384.</b>	<b>Gasket, Flange</b>	<b>4</b>
45	<b>670.006.115.</b>	<b>Retainer, Flap Valve</b>	<b>4</b>
46	807.016.330.	Stud	12
47	170.023.330.	Capscrew, Hex Head	4
48	545.007.330.	Nut, Hex	20
49	807.018.110.	Stud	8
50	547.002.115.	Nut, Stop	8
51	334.020.000.	Flange, Follower	4
52	<b>360.021.000.</b>	<b>Gasket</b>	<b>4</b>
53	170.055.330.	Capscrew, Hex Head	12
54	901.006.330.	Flat Washer	14
55	170.095.330.	Capscrew, Hex Head	2
56	196.060.010.	Chamber, Outer	2
57	312.015.010.	Elbow, Suction	2
58	312.016.010.	Elbow, Discharge	2
59	518.045.010.	Manifold	2
60	338.011.354.	Flap Valve	4
	<b>338.011.356.</b>	<b>Flap Valve</b>	<b>4</b>
	338.011.357.	Flap Valve	4
	338.008.360.	Flap Valve	4
	338.008.365.	Flap Valve	4
61	<u>570.002.360.</u>	Pad, Hinge,Not used with Santoprene	4
	570.002.364	Pad, Hinge,Used with Santoprene	4
	<b>570.002.365.</b>	<b>Pad, Hinge,Not used with Santoprene</b>	<b>4</b>
62	170.082.330.	Capscrew, Hex Head	14
63	<u>570.010.360.</u>	Pad, Wear	2
	<u>570.010.364</u>	Pad, Wear - Use with Santoprene	2
	<u>570.010.365.</u>	Pad, Wear	2

Not Shown:

031.021.010.	Valve Body Assembly (consists of Items 9, 11, 13, 14, 15, 16, 17)	1
--------------	---	---

#### HDF4-M Type 2

63	334.037.010.	Flange, Adapter	2
64	807.005.330.	Stud	8
65	900.007.330.	Washer, Lock	8
66	545.009.330.	Nut, Hex	8
67	360.036.426.	Gasket, Flange	2

Parts underlined are only available for sale in kits

<b>476.251.000.</b>	<b>AIR END KIT</b> <b>Seals, O-Rings, Gaskets, Air Valve Sleeve and Spool,</b> <b>Pilot Valve Assembly</b>
<b>476.316.000.</b>	<b>AIR END WEAR KIT</b> <b>Seals, O-Rings, Bumpers, Gaskets</b>
<b>476.250.360.</b>	<b>WETTED END KIT</b> <b>Buna Diaphragms Flap Valves, Hinge Pads, Gaskets</b>
<b>476.250.365.</b>	<b>WETTED END KIT</b> <b>Neoprene Diaphragms, Flap Valves, Hinge Pads, Gaskets</b>
<b>476.250.632.</b>	<b>WETTED END KIT</b> <b>Neoprene Diaphragms and Hinge Pads, Hytrel Flap</b> <b>Valves, Gaskets</b>
<b>476.250.354.</b>	<b>WETTED END KIT</b> <b>Santoprene Diaphragms and Flap Valves, EPDM Hinge Pads</b> <b>and Wear Pads, Nitrile Gaskets</b>

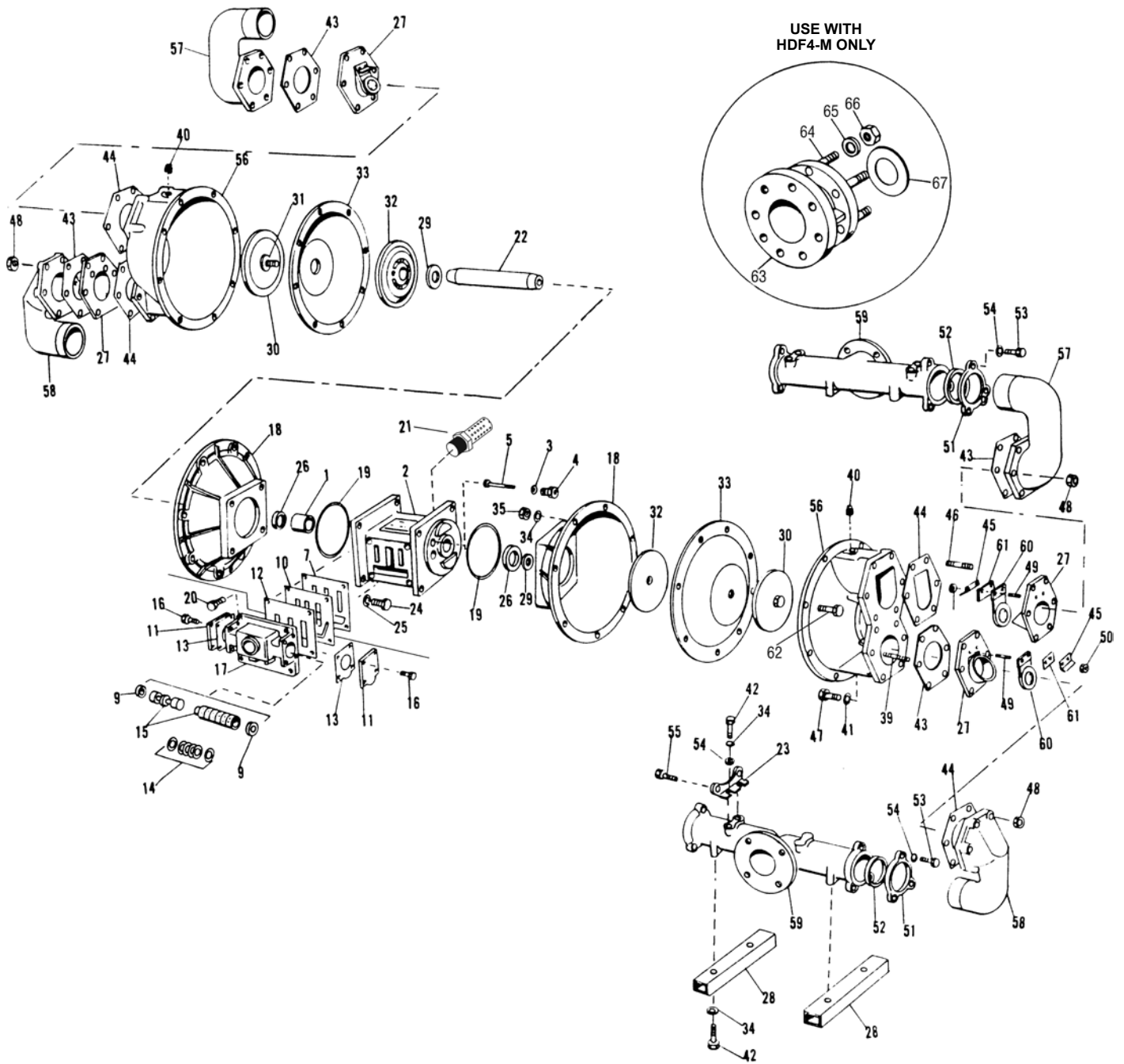

©2010 Warren Rupp, Inc. All rights reserved.  
 ®SANDPIPER are registered trademarks of Warren Rupp, Inc.

# 5 - YEAR Limited Product Warranty

Warren Rupp, Inc. ("Warren Rupp") warrants to the original end-use purchaser that no product sold by Warren Rupp that bears a Warren Rupp brand shall fail under normal use and service due to a defect in material or workmanship within five years from the date of shipment from Warren Rupp's factory. Warren Rupp brands include Warren Rupp®, SANDPIPER®, MARATHON®, PortaPump®, SludgeMaster™ and Tranquilizer®.

~ See [sandpiperpump.com/content/warranty-certifications](http://sandpiperpump.com/content/warranty-certifications) for complete warranty, including terms and conditions, limitations and exclusions. ~

**WARREN  
RUPP, INC.**

## Declaration of Conformity

Manufacturer: Warren Rupp, Inc., 800 N. Main Street  
Mansfield, Ohio, 44902 USA

Certifies that Air-Operated Double Diaphragm Pump Series: HDB, HDF, M Non-Metallic, S Non-Metallic, M Metallic, S Metallic, T Series, G Series, U Series, EH and SH High Pressure, RS Series, W Series, SMA and SPA Submersibles, and Tranquilizer® Surge Suppressors comply with the European Community Directive 2006/42/EC on Machinery, according to Annex VIII. This product has used Harmonized Standard EN809:1998+A1:2009, Pumps and Pump Units for Liquids - Common Safety Requirements, to verify conformance.

David Roseberry  
Signature of authorized person

David Roseberry  
Printed name of authorized person

Revision Level: F

October 20, 2005  
Date of issue

Engineering Manager  
Title

August 23, 2012  
Date of revision

**IBEX**

**CE**



# **WARREN RUPP, INC.**

## **EC / EU Declaration of Conformity**

The objective of the declaration described is in conformity with the relevant Union harmonisation legislation: Directive 94/9/EC (until April 19, 2016) and Directive 2014/34/EU (from April 20, 2016).

**Manufacturer:**

Warren Rupp, Inc.  
A Unit of IDEX Corporation  
800 North Main Street  
P.O. Box 1568  
Mansfield, OH 44902 USA

**Applicable Standard:**

EN13463-1: 2001  
EN13463-5: 2003  
EN60079-25: 2004

**Harmonised Standard:**

EN13463-1: 2009  
EN13463-5: 2011  
EN60079-25:2010

The harmonised standards have been compared to the applicable standards used for certification purposes and no changes in the state of the art technical knowledge apply to the listed equipment.

**AODD Pumps and Surge Suppressors**

Technical File No.: 203104000-1410/MER

**AODD (Air-Operated Double Diaphragm) Pumps**

EC Type Examination Certificate No. Pumps: KEMA 09ATEX0071 X

DEKRA Certification B.V. (0344)  
Meander 1051  
6825 MJ Arnhem  
The Netherlands

**Hazardous Locations Applied:**

I M1 c	II 1 G c T5
II 2 G Ex ia c II CT5	II 1 D c T100°C
II 2 D Ex c iaD 20 IP67 T100°C	II 2 G c T5
II 2 G Eex m c II T5	II 2 D c T100°C
II 2 D c IP65 T100°C	

**SANDPIPER®**  
A WARREN RUPP, INC. BRAND

**Tranquilizer®**

DATE/APPROVAL/TITLE:  
18 March 2016

*David Roseberry*  
David Roseberry, Director of Engineering

**IDEX**