

CIRCUMFERENTIAL PISTON PUMP



# TRA20SERIES



**wright flow**  
TECHNOLOGIES<sup>®</sup>

**Capacity** to 102 m<sup>3</sup>/hr / 450 GPM

**Pressure** to 34 Bar / 500 PSI

**Viscosity** to 200,000 cSt / 910,000 SSU

**Temperature** to 150° C / 300° F

HYGIENIC PUMP SOLUTIONS

**IDEX**  
FLUID & METERING

# YOUR COMPLETE Hygienic Solutions Provider

- GLOBAL PRESENCE WITH LOCALIZED SERVICE
- BROADEST PD PUMP OFFERING IN THE INDUSTRY
- COMPLETE PARTNER FOR YOUR HYGIENIC PROCESS



Around the world, Wright Flow Technologies provides solutions for challenges in fluid handling. You can count on the reliability of Wright Flow hygienic positive displacement (PD) pumps. Matching the right pump with your fluid processing needs is easy with innovative, robust designs, cleanability & an extensive product offering.

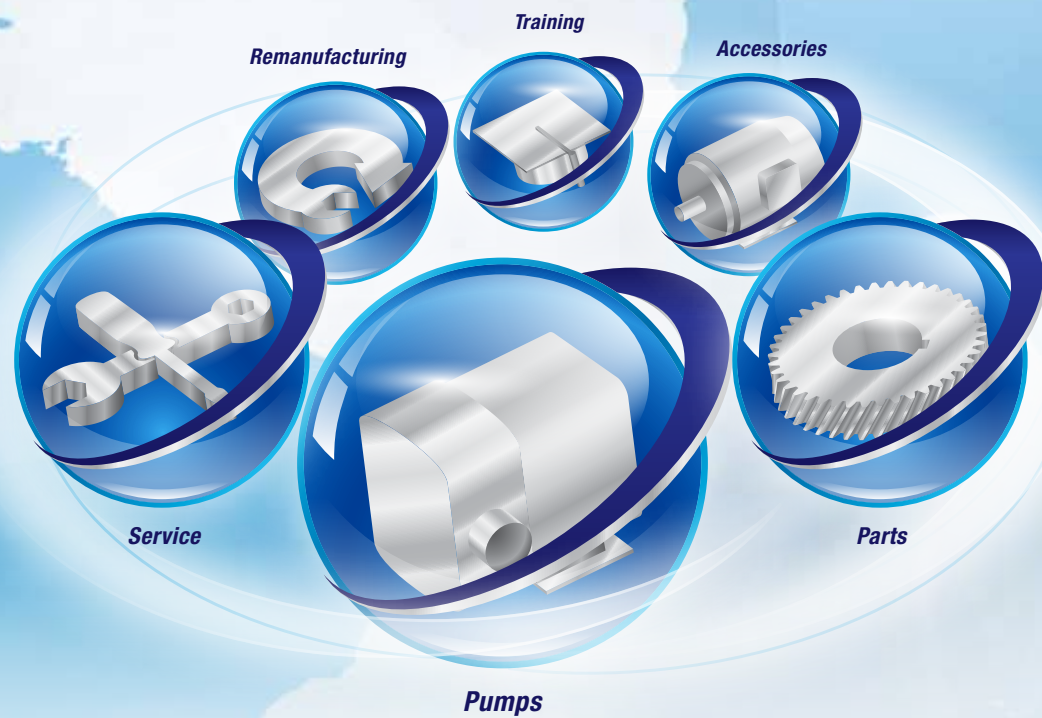

## TRA20 SERIES

The TRA20 Series pumps can be built for CIP processing environments with added options, with internal design to allow vigorous flushing through all internal chambers. A very robust performer, the TRA20 Series pumps allow the highest pressure capabilities in the Wright Flow line.



### How it Works

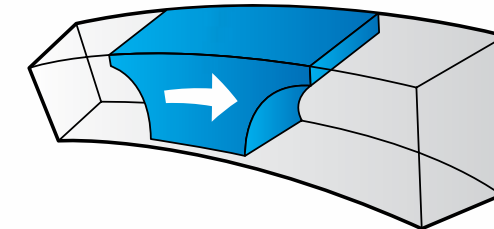

The deep channels in which the rotors travel provide large voids to minimize shear and bruising of solids.

### Suction

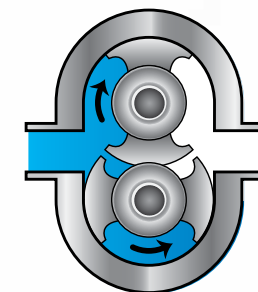

Wright Flow Technologies rotor wings (pistons) rotate around the circumference of the channel in the pump casing. This continuously generates a partial vacuum at the suction port as the rotors unmesh, causing fluid to enter the pump.

### Discharge

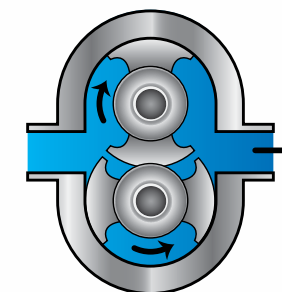

The fluid is transported around the channel by the rotor wings & is displaced as the rotor wings re-mesh, generating pressure at the discharge port. Pump output is directly proportional to speed & direction of flow is reversible.

**CHEMICAL**  
Raw Ingredients, Chemical Transfer, Solvent Recovery

**PERSONAL CARE**  
Skin Care Products, Toothpastes, Cosmetics, Shower & Shaving Liquids, Hair Care Products

**BEVERAGES**  
Distillers & Vinters, Fruit & Vegetable Purees, Carbonated Drinks, Juices

**FOOD**  
Baby Food, Edible Oils, Soft Fruits & Vegetables, Soups & Sauces, Egg, Fish, Meat, Poultry, Whey Proteins, Confectionary

**DAIRY**  
Butter, Cheese, Cream, Milk, Yogurt, Yogurt Fruits

**BIO PHARMACEUTICAL**  
Creams & Ointments, Ferment, Injectables, Ultra Filtration, Blood & Plasma Processing



# TRA20SERIES



## CLEANABILITY

- CIP (Clean In Place) design optional
- Free draining cover with flat body profile option
- Sealed shaft with o-ring on rotor & rotor nut

## PERFORMANCE

- Efficient handling for low & high viscosity applications
- Exclusive, non-galling WFT 808® alloy rotors standard; permits running at tighter clearances
- High strength 17-4 PH single piece shaft standard
- Improved load carrying capabilities

## EASE OF MAINTENANCE

- Drop-in-place with TRA10 & comparable manufacturer models
- Interchangeable service parts with comparable manufacturer models
- Stainless steel bearing retainers standard, prevent rusting

## Remanufacture & Save!

SIGNIFICANT SAVINGS COMPARED TO PURCHASING NEW

### WHY REMANUFACTURE?

- Worn pump is returned to **like-new condition & performance**
- Your remanufactured pump carries a **full 1 year factory warranty**
- All remanufactured pumps are **tested & certified**
- **Save big** compared to purchasing an entirely new pump
- Pumps can be remanufactured **up to three times**, depending on model & wear



### WHAT YOU GET:

- NEW ROTORS
- NEW BEARINGS
- NEW SEAL COMPONENTS
- NEW SHAFTS
- NEW GEARS



**PORTING:**

- Complete range of hygienic clamp, screw, flange & industrial screw connections
- Tri-clamp, flanged, DIN, IMDA, NPT, BSP, etc.

**Tri-Clamp**

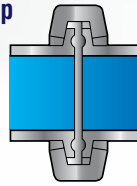

**Bevel Seat (ACME)**

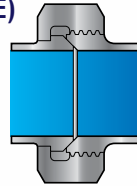

**SEAL:**

- Single mechanical
- Double mechanical w/ flush
- Complete range of material options

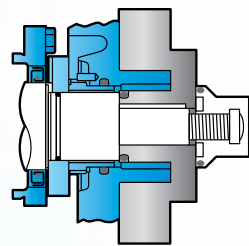

**Single Mechanical Seals**

- Standard Seal Faces: *SiC/SiC*
- Standard O-rings and Cover Seals: *Buna/FDA*
- Optional Faces: *Carbon, Ceramic or Chrome Oxide*
- Optional O-rings and Cover Seals: *FKM, EPDM, Silicone*

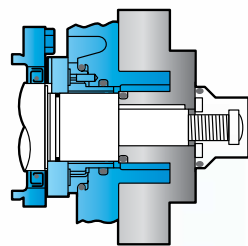

**Double Mechanical Seals with Flush**

- Standard Seal Faces: *SiC/SiC/C*
- Standard O-rings and Cover Seals: *Buna/FDA*
- Optional Faces: *Carbon, Ceramic or Chrome Oxide*
- Optional O-rings and Cover Seals: *FKM, EPDM, Silicone*

**ROTOR & CASING OPTIONS:**

- 316 stainless steel pump casing w/ interior finished to 3-A standards
- Non-galling WFT 808® nickel alloy rotors standard or 316 stainless steel rotors optional
- Optional clearances: front face, hot, high temperature/high viscosity (chocolate)
- Clean In Place (CIP) & flat body profile available

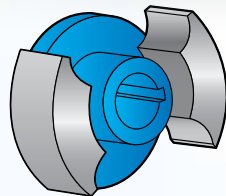

**Twin Wing Rotors Standard**

Suitable for all liquids, provides minimum pulsation.

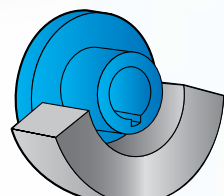

**Single Wing Rotors Optional**

Provides reduced shear on shear sensitive fluids or large solids such as fruit pieces, nut kernels, cheese curds or meats.

**GEAR BOX:**

- Powder-coated standard
- 304 stainless steel optional

**MOUNTING:**

- A gear case that can be mounted in any of four positions allows for horizontal or vertical porting, flexibility in drive shaft positioning to match reducer or gear motor input, & improved access to grease fittings

**CIP FEATURES AVAILABLE:**

- Flat body profile
- CIP holes in body and rotors
- Vertical port mounting
- Extra clearance rotors

**PERFORMANCE RANGE:**

- CAPACITY** to 102 m<sup>3</sup>/hr / 450 USGPM
- PRESSURE** to 34 BAR / 500 PSI
- VISCOSITY** to 200,000 cSt / 910,000 SSU
- TEMPERATURE** to 150°C / 300°F

COMPLIANT WITH THE FOLLOWING STANDARDS



TRA20 Model	Displacement		Max Pressure		Max Speed	Standard Ports		Max Capacity		Max Temperature	
	l/rev.	USG/rev.	BAR	PSI	RPM	mm	in.	m <sup>3</sup> /hr	USGPM	Deg. C	Deg. F
0060	0.03	0.008	21	300	1000	25.4	1	1.8	8	150	300
0150	0.052	0.014	17	250	800	38	1.5	2.5	11	150	300
0180	0.108	0.029	14	200	700	38	1.5	4.5	20	150	300
0300	0.227	0.06	17	250	600	38	1.5	8.2	36	150	300
0450	0.366	0.096	31	450	600	51	2	13.2	58	150	300
0600	0.568	0.15	21	300	600	64	2.5	20.4	90	150	300
1300	0.946	0.25	14	200	600	76	3	34.1	150	150	300
1800	1.45	0.383	31	450	600	76	3	52.2	230	150	300
2100	1.89	0.5	34	500	600	102	4	68.1	300	150	300
2200	1.95	0.516	21	300	600	102	4	70.4	310	150	300
3200	2.85	0.75	21	300	600	152	6	102	450	150	300

TRA20 Rectangular Flange Model	Displacement		Max Pressure		Max Speed	Inlet (WxL)		Outlet		Max Capacity		Max Temperature	
	l/rev.	USG/rev.	BAR	PSI	RPM	mm	in.	mm	in.	m <sup>3</sup> /hr	USGPM	Deg. C	Deg. F
0340	0.23	0.06	14	200	400	44.50 x 171.45	1.75 x 6.75	38.1	1.5	5.4	24	150	300
0640	0.57	0.15	14	200	400	56.90 x 224.03	2.24 x 8.82	57.15	2.5	13.6	60	150	300
1340	0.95	0.25	14	200	400	75.44 x 234.95	2.97 x 9.25	76.2	3	22.7	100	150	300
2240	1.95	0.52	14	200	400	98.30 x 279.40	3.87 x 11.00	101.6	4	45.4	200	150	300

Note: Hot clearances required for high temperature operation.

# Preventive Maintenance Kits

ENSURE TROUBLE-FREE OPERATION & SUPERIOR PERFORMANCE



## BENEFITS OF MAINTENANCE KITS:

- Everything you need in one place
- Reduce frequency of repairs
- Increase service life
- Increase uptime
- Save time & money
- Kits include exploded diagram & parts list



## REBUILD VS. REPLACE:

- Wright Flow kits are designed to save time & money, making preventive maintenance & rebuilding easier & more cost-effective
- Wright Flow pumps are designed & built to the highest standards, for long life & to be rebuilt instead of replaced when applicable
- Tool kits also available

## BACK OF MAINTENANCE KIT:

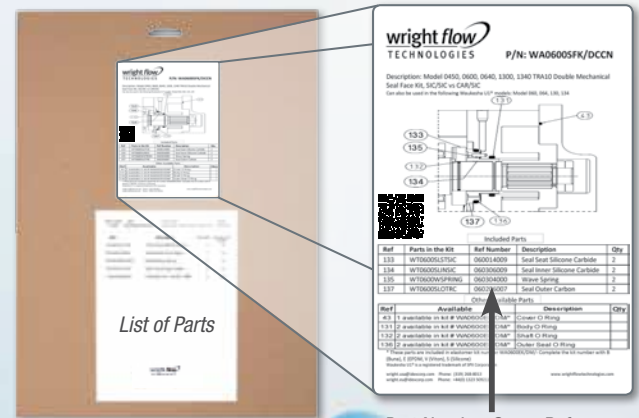

List of Parts

Part Number Cross-Reference



FOR MORE INFORMATION, CONTACT YOUR LOCAL AUTHORIZED WRIGHT FLOW TECHNOLOGIES DISTRIBUTOR OR CONTACT US AT:

**WRIGHT FLOW TECHNOLOGIES, INC.**  
406 State Street  
Cedar Falls, IA 50613 USA  
Phone: (319) 268-8013 • E-mail: [wright.usa@idexcorp.com](mailto:wright.usa@idexcorp.com)

**WRIGHT FLOW TECHNOLOGIES LTD.**  
Highfield Industrial Estate, Edison Road Eastbourne  
East Sussex, United Kingdom, BN23 6PT  
Phone: +44(0) 1323 509211 • E-mail: [wright.eu@idexcorp.com](mailto:wright.eu@idexcorp.com)

**WRIGHT FLOW TECHNOLOGIES SUZHOU**  
Block 6, No.428 Xing Long Street  
Su Chun Industrial Square, Suzhou Industrial Park  
Suzhou 215126, China  
Phone: (0512) 62833000\*333

Distributed By:

[WRIGHTFLOWTECHNOLOGIES.COM](http://WRIGHTFLOWTECHNOLOGIES.COM)

